



Installation guidelines GGS with counterweight







List of documentation

1 NOTIFICATION BEFORE INSTALLATION.....	1
2 CONTROL THE COMPLETENESS OF DELIVERY.....	2
3 BUILDING CONTROL BY A PARTICULAR MODEL KITS.....	5
4 INSTALLATION SECTIONS OF THE DOOR.....	6
4.1 Vertical sections setting	6
4.1.1 Door sections without integrated rotary wing	6
4.1.2 Door sections with integrated rotary wing	7
4.1.2.1 Version A.....	7
4.1.2.2 Version B.....	8
4.2 Horizontal sections setting	9
5 INSTALLATION OF THE GUIDE TRACKS AND GUIDING WHEELS.....	11
6 INSTALLATION OF THE CROSSBEAM GUIDE TRACKS	14
7 INSTALLATION CONSOLES OF BARING PULLEYS.....	15
8 STRUCTURE OF CONSOLE	16
9 INSTALLATION OF COUNTERWEIGHT AND ROPE	17
10 COUNTERWEIGHT FILLING.....	18
11 TRACK COVERING OF COUNTERWEIGHT.....	19
12 INSTALLATION OF DOORFRAME PROFILES	20
13 INSTALLATION OF THE ELECTROMAGNETIC BRAKE	21
14 INSTALLATION OF STOPS	23
15 CONNECTION OF CONTROL PANEL.....	24
16 GUARANTEE CONDITIONS	25

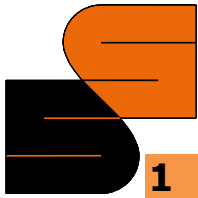

1 NOTIFICATION BEFORE INSTALLATION

Dear customer,

We are glad that you decided to fire sectional doors from Somat system Ltd.

Please read these instructions and follow them. It gives you important information about the safe installation and operation of your doors and specialized maintenance and repairs.

Professional service and careful maintenance significantly affects performance and usability of the device gate. Operating errors and improper maintenance lead to operational faults, which can be avoided. Your satisfaction and long-term operational reliability is ensured only when the professional operation and careful maintenance.

Important instructions:

- Follow the instructions in this manual
- Improper installation or improper maintenance the door could lead to life-threatening injuries. For your own safety check carried out by a qualified professional installation of company
- Transport sections of the door only on the special pallet
- The doors open and close horizontally. For this reason, ensure that the the door during operation in the area of the door not stay any people - especially children - and no objects
- The appliance the door, use only if it is in perfect condition. Equipment failure the door can lead to life-threatening injuries
- Ensure that all the checks, repairs and cleaning equipment can not operate the door by a third party
- Do not alter or remove any functional parts! This may cut out important safety components
- Do not install any additional components. All components are precisely adjusted to each other. Additionally, components may overload the the door structure and lead to life-threatening injuries

Working tools:

- Use only tools suitable for the installation of doors and related equipment

Prepare the following working tools:











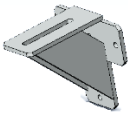

- **Suitable lifting equipment (truck crane)**
- **Suitable lifting platform or scaffolding**
- **Drill**
- **Grinder**
- **Set of keys**
- **Optical leveling device**
- **Aku screwdriver**
- **Taps (for mounting on a steel structure)**





2 CONTROL THE COMPLETENESS OF DELIVERY







Before installation, remove the technical drawing package and packing list and verify that the shipment corresponds to the packing list.

1. Set of consoles for reeling roller		
1.1.		3 pcs console
1.2.		3 pcs pulley
1.3.		Counterweight
1.4.		Granulate sack
1.5.		Supporting steel rope
1.6.		2 pcs eye socket
1.7.		4 - 6 pcs cable clip
1.8.		Connecting material
2. Pojezdové dráhy		
2.1.		Left track (J profil + track)
2.2.		Right track (J profil + track)
2.3.		Connecting material
3. Labyrinths		
3.1.		Upper labyrinth
3.2.		2 pcs side labyrinth
3.3.		Crossbeam guide tracks (min. 2 pcs, more for higher door)
3.4.		Connecting material





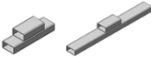







4. Door sections

4.1.		Door section (vertical or horizontal)
4.2.		2 pcs guiding wheels
4.3.		2 pcs guiding wheels with lock
4.4.		Top profile – door labyrinth (in case of horizontal section is mounted on the top of section)
4.5.		Threaded rods
4.6.		Top and bottom reinforcing profile
4.7.		2 pcs mounting eye (only for horizontal section)
4.8.		Connecting material

5. Floor stop





5.1.		2 pcs floor stop
5.2.		Track cover
5.3.		Connecting material

6. Controls

6.1.		Bracket
6.2.		Brake Linig (installed on 6.1)
6.3.		Pulley PVC (install on 6.3)
6.4.		Rope
6.5.		Door pull
6.6.		Control panel Slidetronic or Slidetronic II or Blocktronic
6.7.		Connecting material





7. Additional equipment – according to specifics an order (e.g.)		
7.1.		Temperature sensor
7.2.		Somke sensor
7.3.		Combi sensor
7.4.		Siren with flash beacon
8. Mounting material – are delivered in standard bolts for mounting to the structure – can be ordered according to the type of supporting structure (walls, steel construction ...)		

Recommended anchors

Type of wall	Consoles	Profiles	Wall	Horizontal bar
Concrete	Wedge Anchor (10x90 or 12x110)	screw + anchor		
Steel	Screw + nut + washer	Tex 6,3		
Porottern	Anchoring through the wall - distributing pads under the console	Fischer FUR		
Plynosilikat				





3 BUILDING CONTROL BY A PARTICULAR MODEL KITS

- The values you can find in the attached
- Mark the center of the opening
- Create-meter mark on both sides of the the door opening (must be horizontal to the ground)
- If either of greater dimensions than the doors according to the documentation. Doors can not be installed (less than or as large as in the documentation)

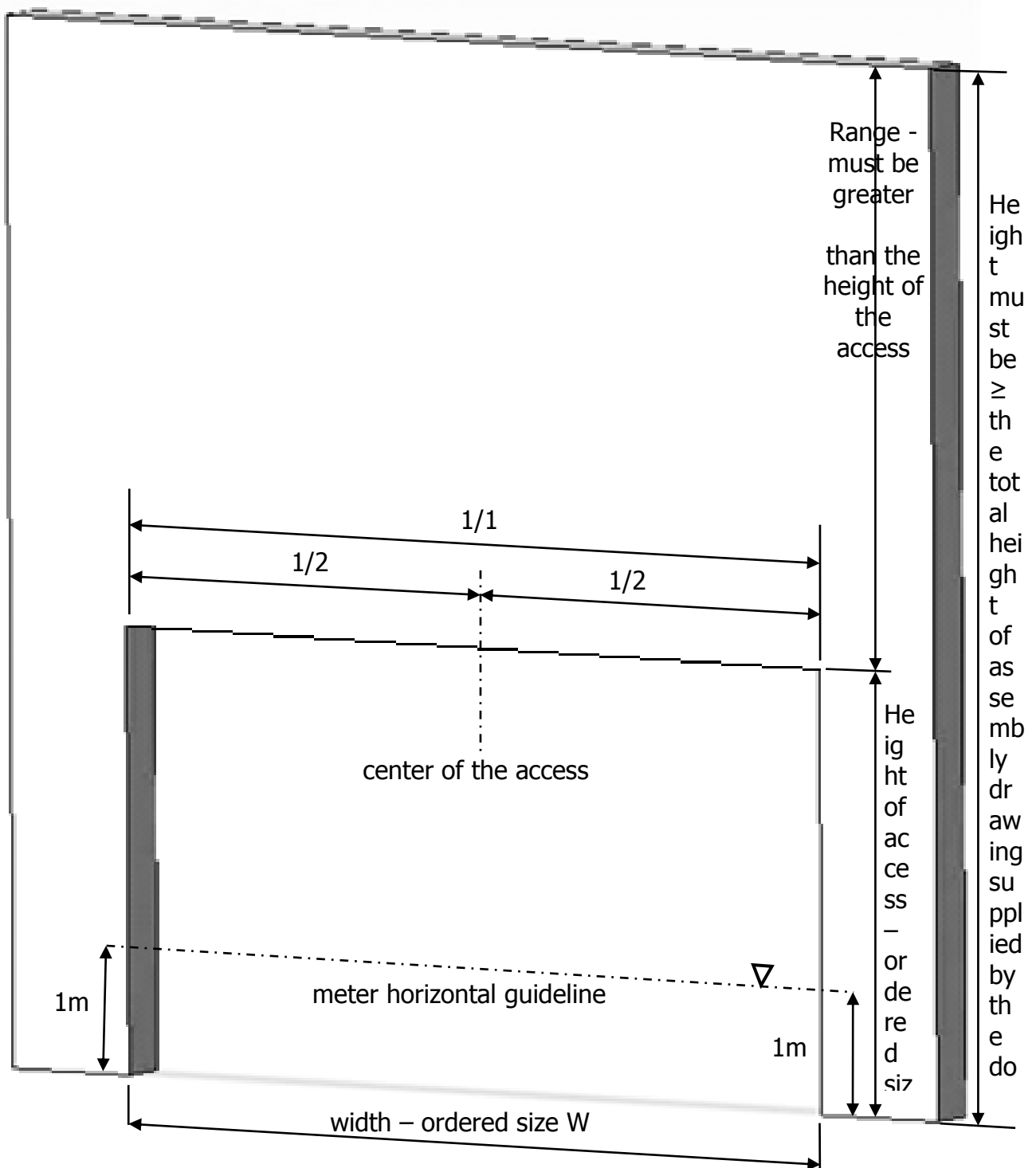



4 INSTALLATION SECTIONS OF THE DOOR

4.1 Vertical sections setting

4.1.1 Door sections without integrated rotary wing

In this case, it is possible to install a guide tracks (installation of track see Section 5) before assembling the wings. The connecting threaded rods are pushed from one side. The position of each section and download the threaded rods (see assembly) – start with section without holes in the side rims, stand the section with guiding wheels in the track (installation the guiding wheels for the position 1.section see Item 6). Installation of guiding wheels section is secured against the fall and gradually build the next section.

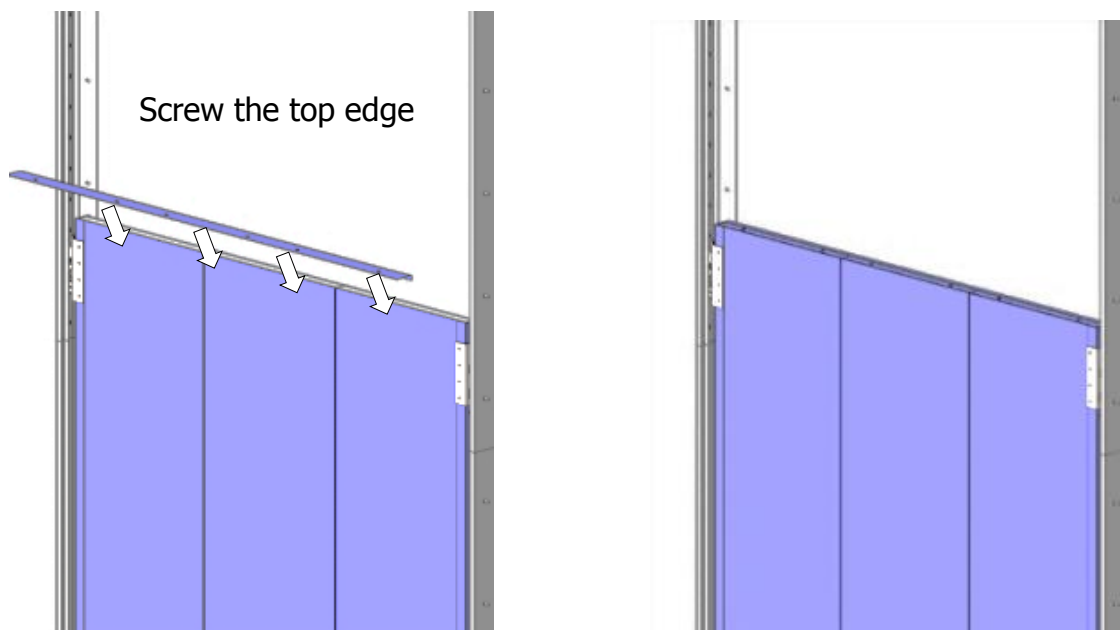
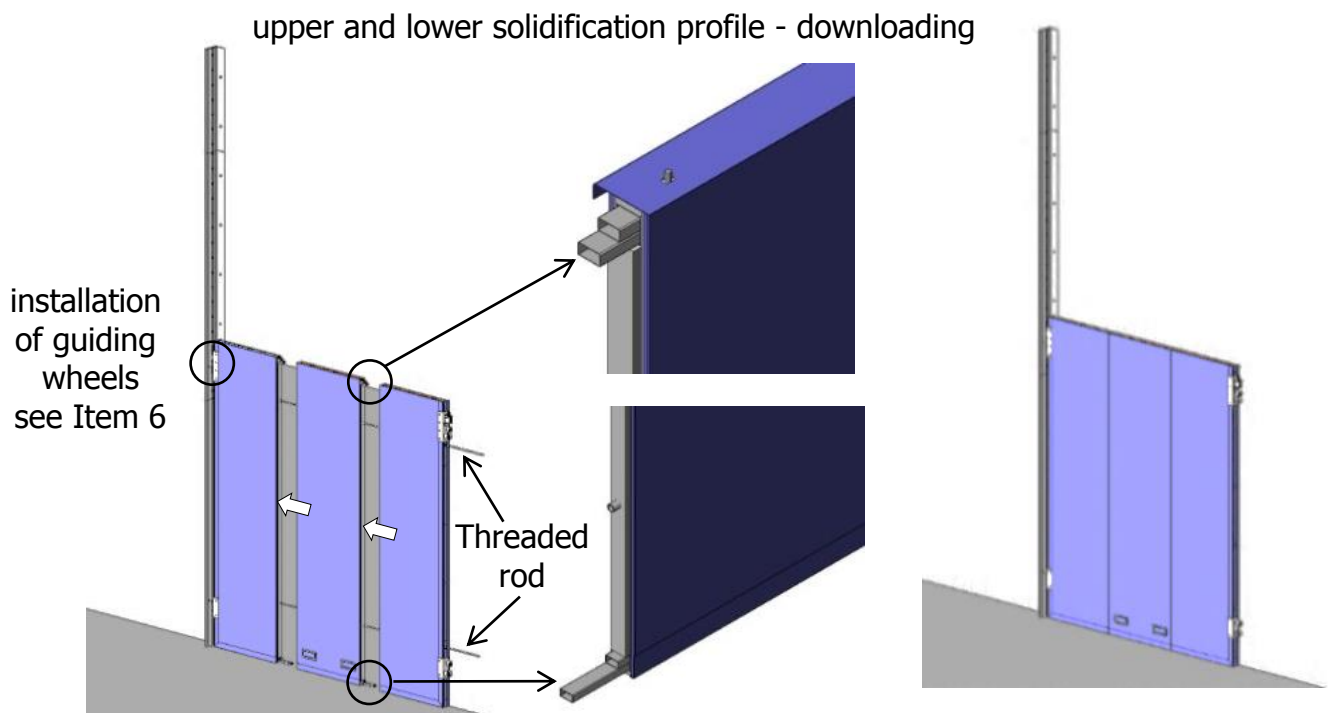



4.1.2 Door sections with integrated rotary wing

Threaded rods are pushed on both sides of the wings. In the case of the assembly wing in the constructed position (can not be mounted by any of the tracks).

4.1.2.1 Version A

Assembly sections in base position (recommended for bigger size)

- Place 1. Section and ensure fall protection (fix to the wall)
- Place another section
- Downloading (see above door wing)
- Top of the edge installation (see above door wing)
- Installation of the guide tracks see Item 5

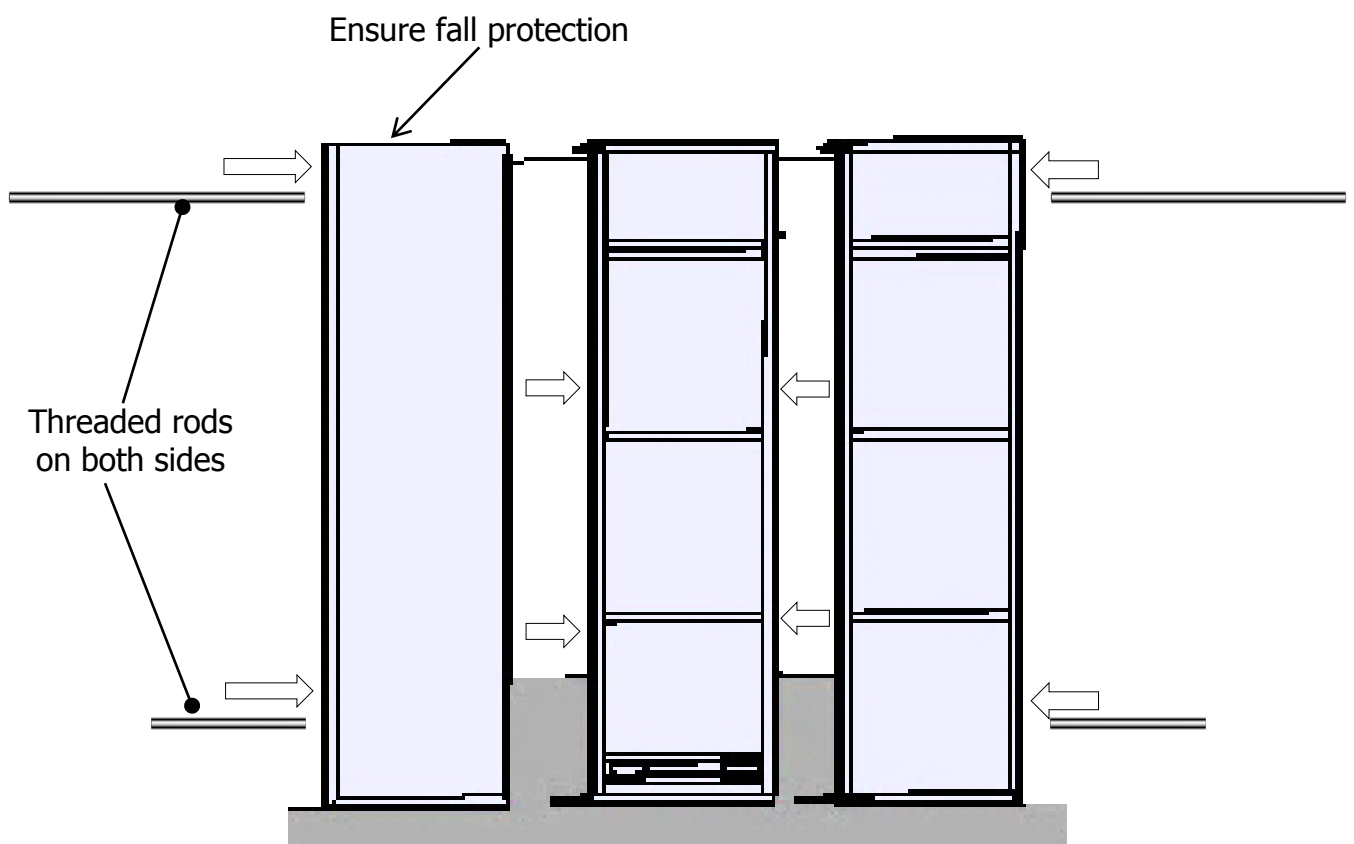



4.1.2.2 Version B

Assembly sections in a horizontal position on the floor or backing and follow position of the wings (for the smaller dimensions of the door)

- Lay the sections
- Downloading (see above no pass door)
- Top of the edge installation
- Stand and ensure the door

Place section to the support and start putting together

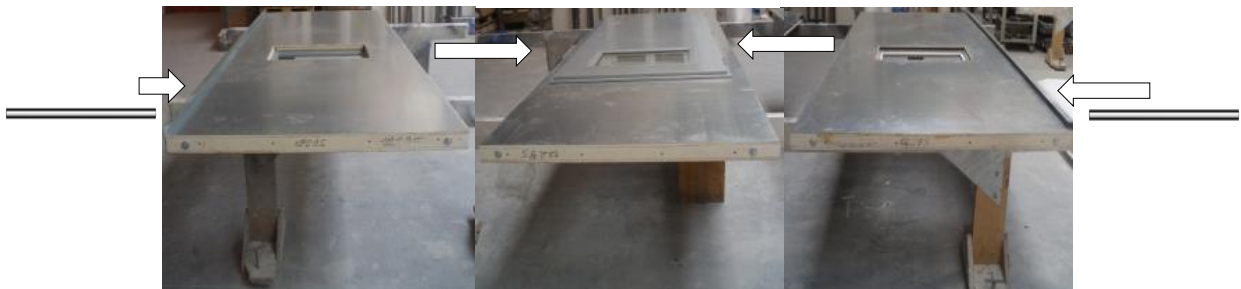

Put and ensure composed door

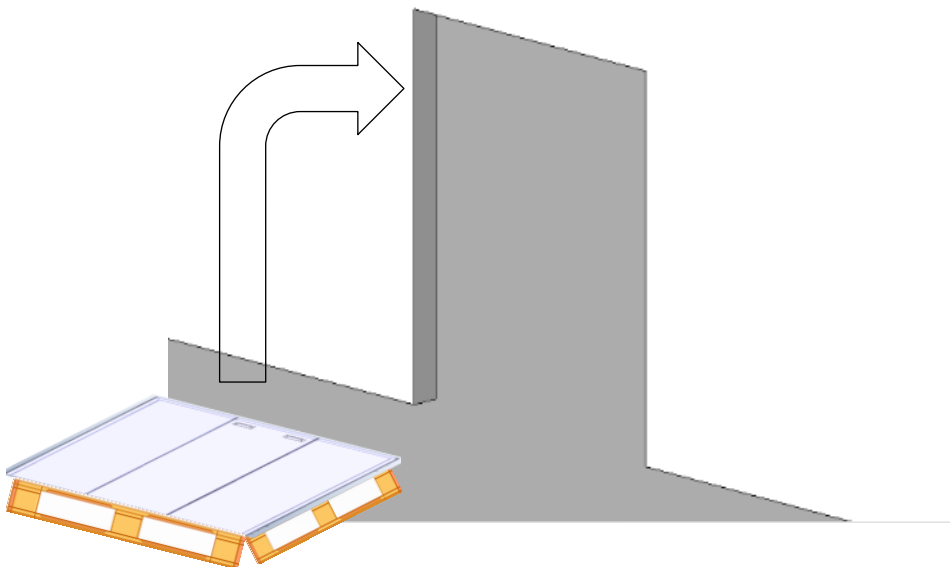

Note: To ensure the position is possible to use pre-assembled one of the guide tracks - installation see Item 5 -> zajištění vrat osazením vozíku (see Item 6).





4.2 Horizontal sections setting

First installation of guide tracks see Item 5 without the door wing. For mounting the sections is necessary mechanization, which is able to lift the the respective weight of sections. Each section has a threaded rods which goes through all the sections, but also the rods, that connect the adjacent sections only.

Note: If you want to use for lifting sections motor of the door -> install complete tracks including the drive see Item 5 – 10.

- Place 1. section by mechanization (lift sections by the retaining points – mounting eye) to the tracks of tracks and ensure by guiding wheels
 - a) 2x handle in the extreme position -> primary designed for lifting the the door by using the motor - reeling on drums
 - b) 1x handle in the middle is primary for lifting with a forklift
- Downloading (see above door wing)
- Figure another section
- Downloading (see above door wing) - repeat the cycle by the number of sections
- Download the entire wing by threaded rods across wing
- Top of the edge installation

Note: Ensure to the track against the fall.

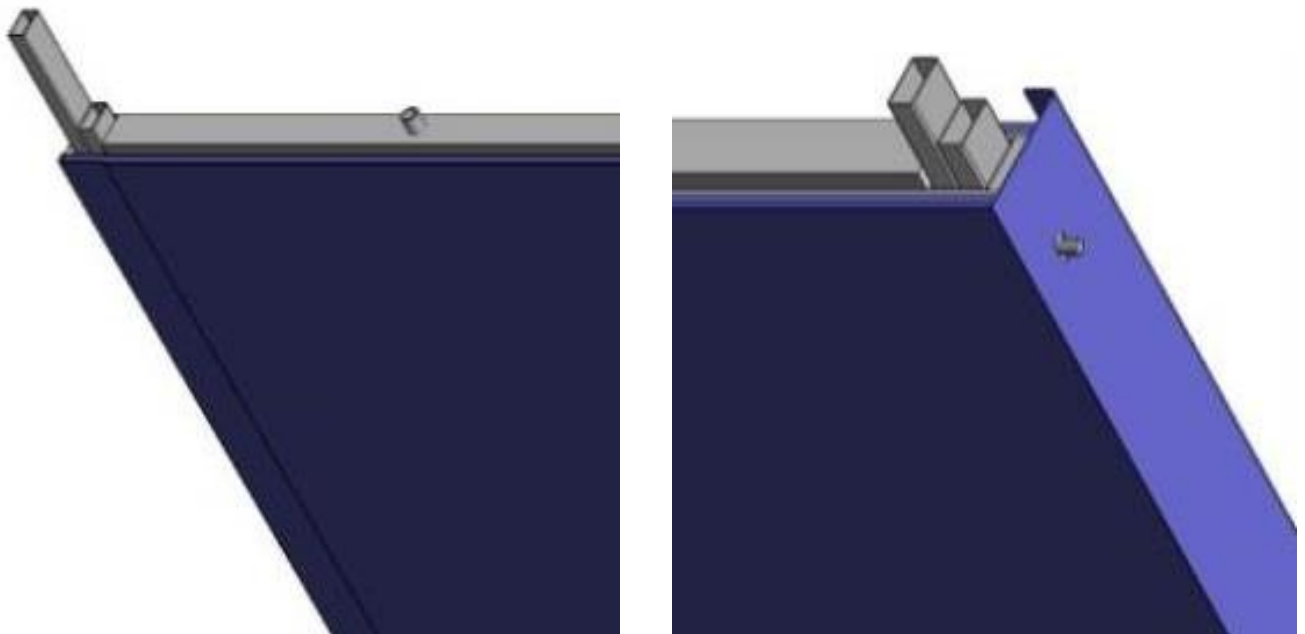

side solidification profile - downloading





Threaded rods:

- Over the whole wing (on the sides and middle)
- Over each section (approaching to each other)



Mounting eye

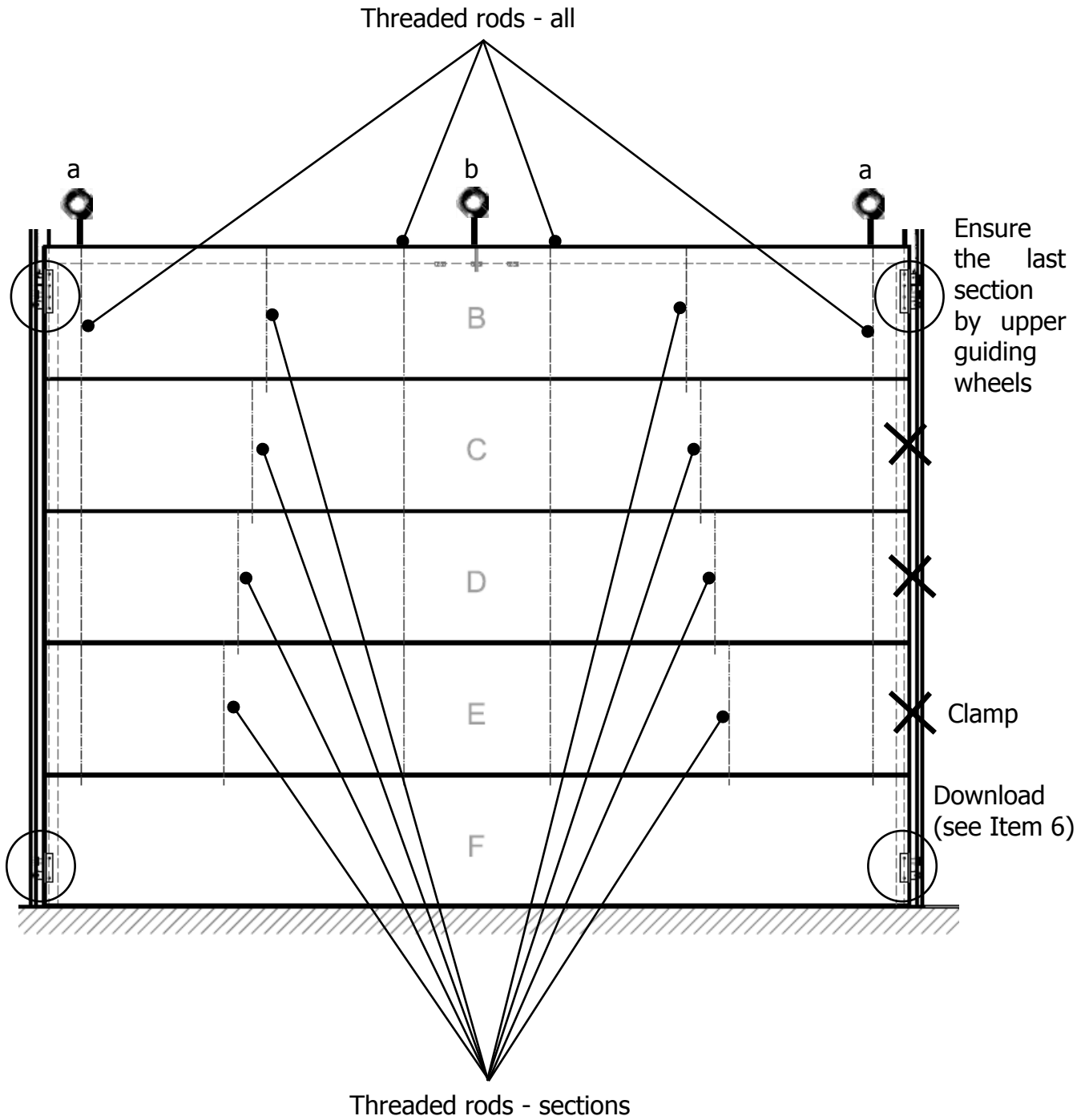



5 INSTALLATION OF THE GUIDE TRACKS AND GUIDING WHEELS

Mount track to the wall of the appropriate connecting material according to the type of wall. The guide track is mounted by screws inside the track (on side can be reduced), then insert the first part of the door.

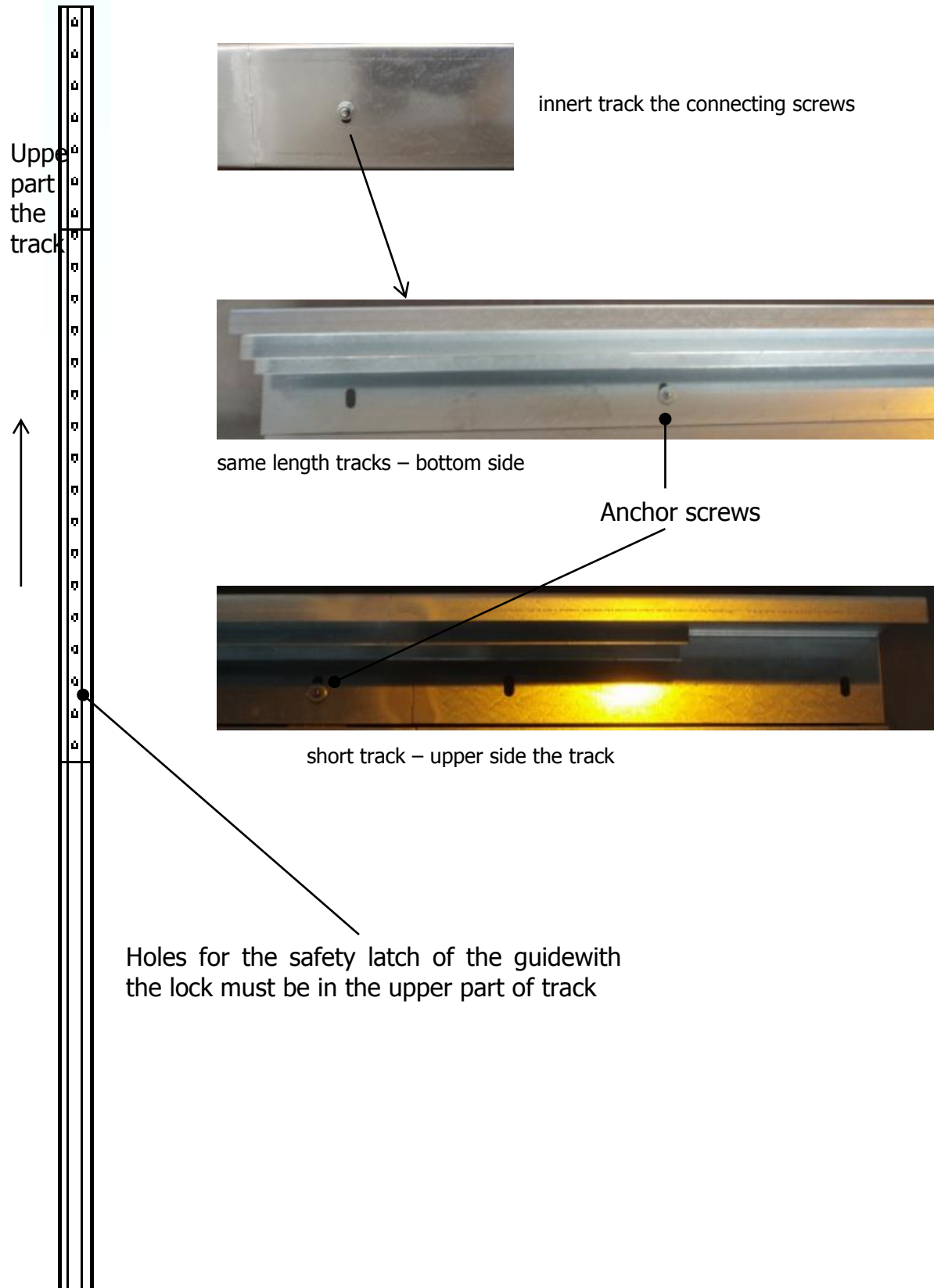



1. Mark 1 m on the guide from the bottom
2. Set the guide tracks to a vertical position
 - a. during installation a door wing with integrated rotary wing, the track settles down to already mounted wing see. 4.1.2.1 (no matter which side we start)
 - b. anchor the track and insert it into the first track wing section (door leaf mount from the opposite side than on the threaded rods are inserted to connect the wings)
3. Drilled track placed always on the top
4. Move track to the door (see detail.)
5. Align track to the vertical plane and anchor it

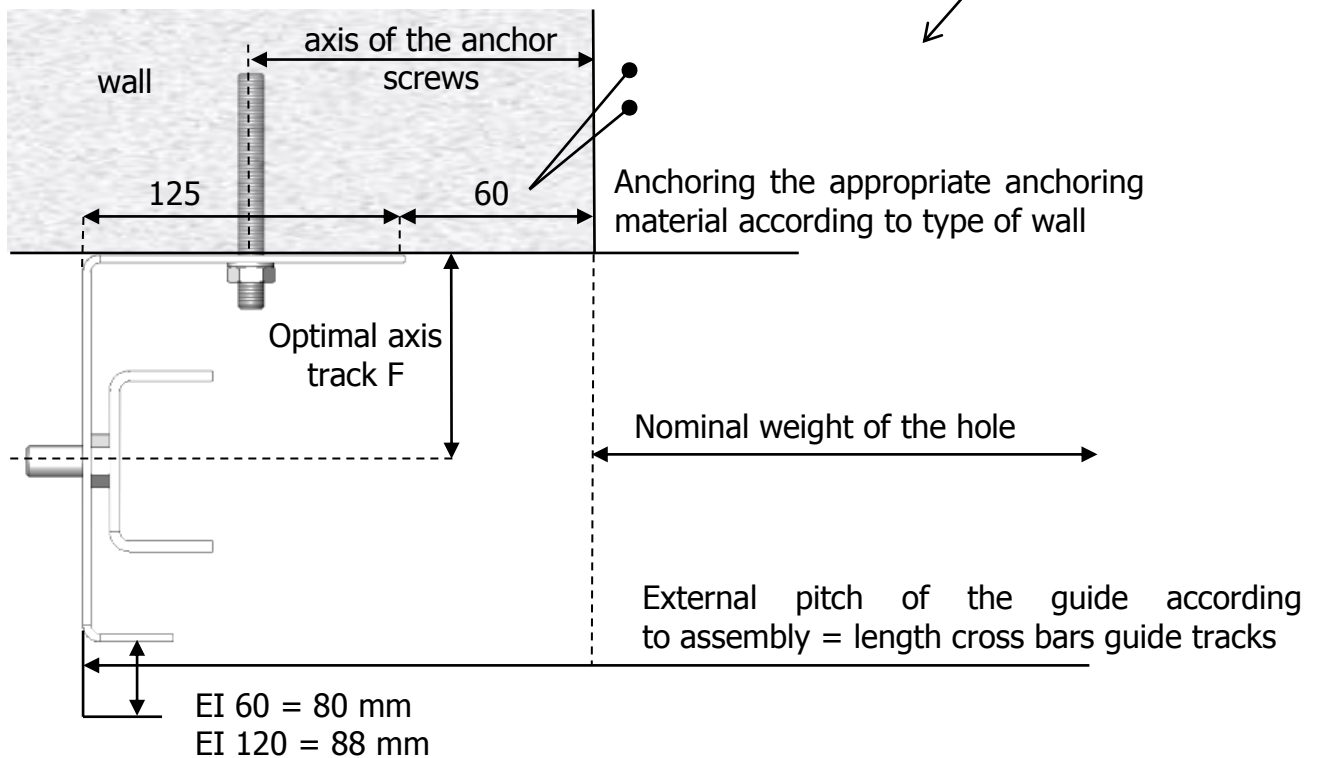
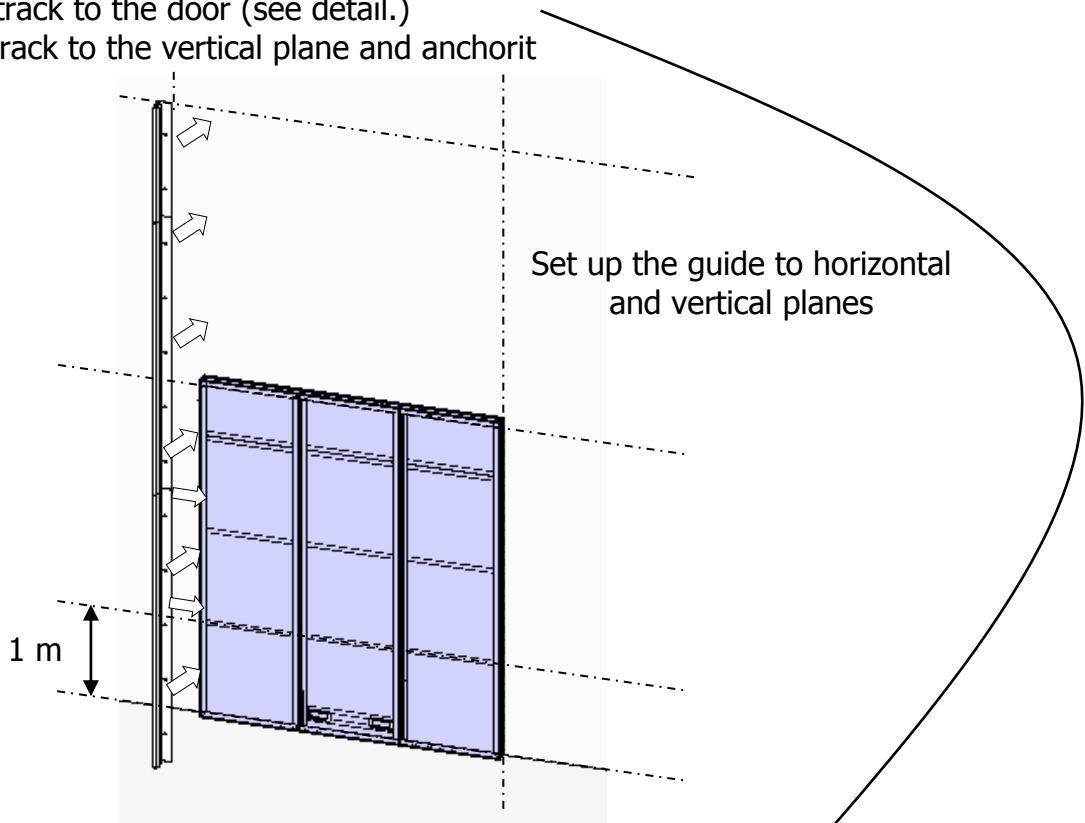



6. Insert the small guiding wheels without insurance on the top of the track and fix it to the wing.
7. Insert the upper guiding wheels on the top of the track and screw to the wing (note Fit the eye socket for rope protection on the lock)

Guiding wheels screw types:

- 12x M6 small guiding wheels
- 12x M12 big guiding wheels

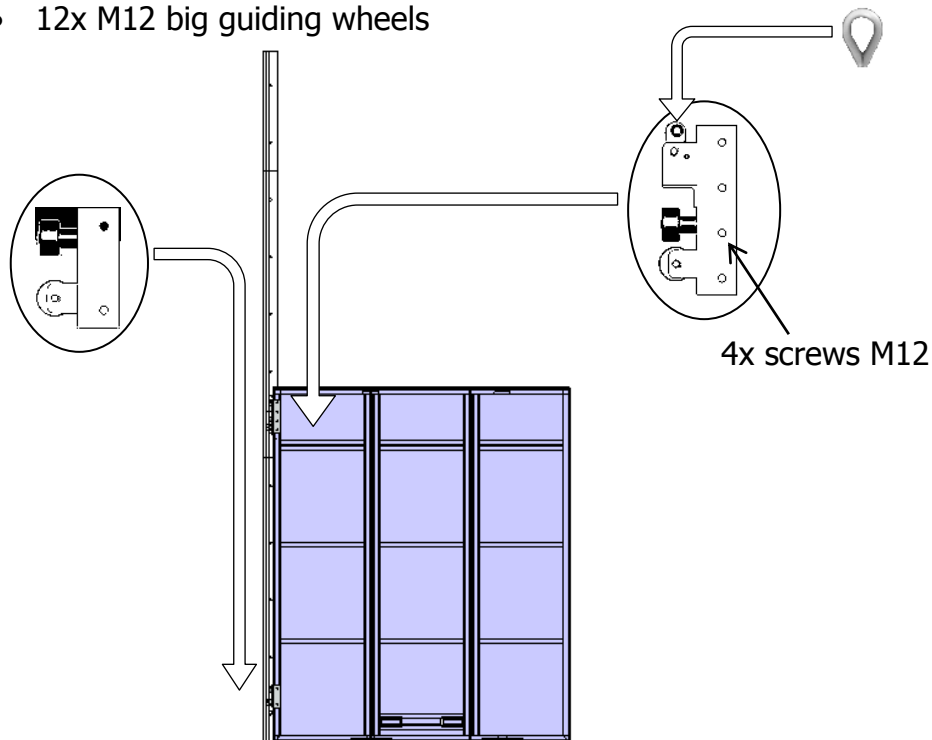

The same procedure of installation tracks and guiding wheels on the opposite side. Establishment according to drawing.

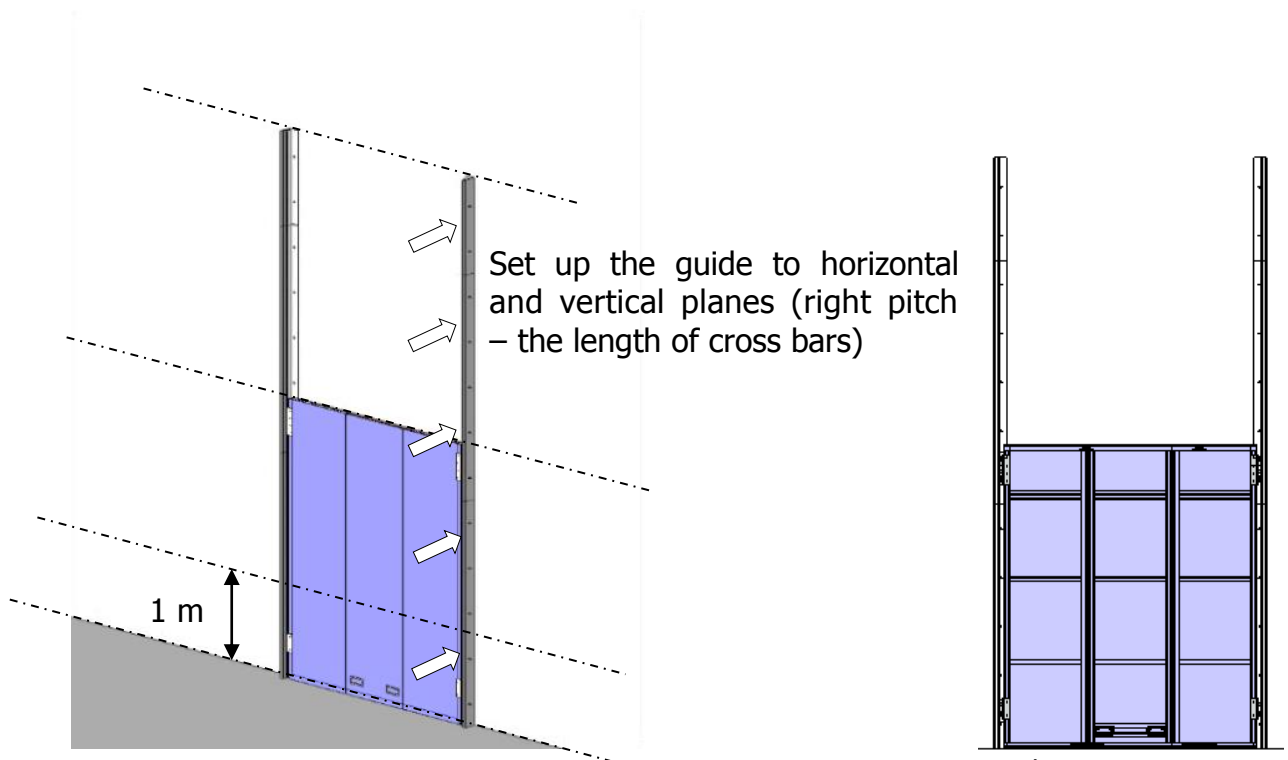

Somati system s.r.o., Jihlavská 510/2c, 664 41 Troubsko
IČ: 29260159, DIČ: CZ29260159
tel: +420 547 427 011, www.somati-system.cz



6 INSTALLATION OF THE CROSSBEAM GUIDE TRACKS

They give us the exact distance of guide tracks from each other. Usually they are in units of 2, but more spacers are at higher door. It serves to the correct ensure safety lock against launching the wheel tracks. Crossbeams are screwed by screws to the track Tex 6,3 or M8.



Ensure the crossbeam to track
by screws Tex 6,3 or M8

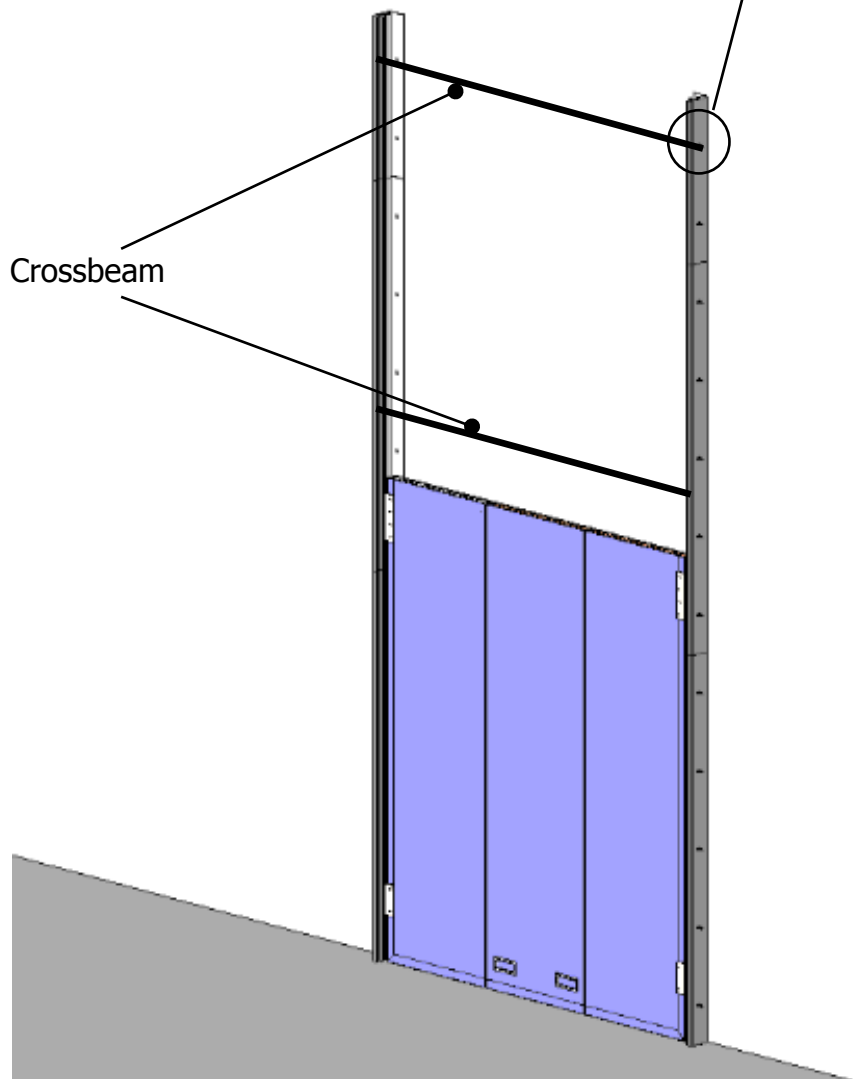



7 INSTALLATION CONSOLES OF BARING PULLEYS

The consoles sit in positions according to the attached technical drawing and anchor the relevant material to the wall. Install the pulleys on the consoles. Consoles are established in one plane.

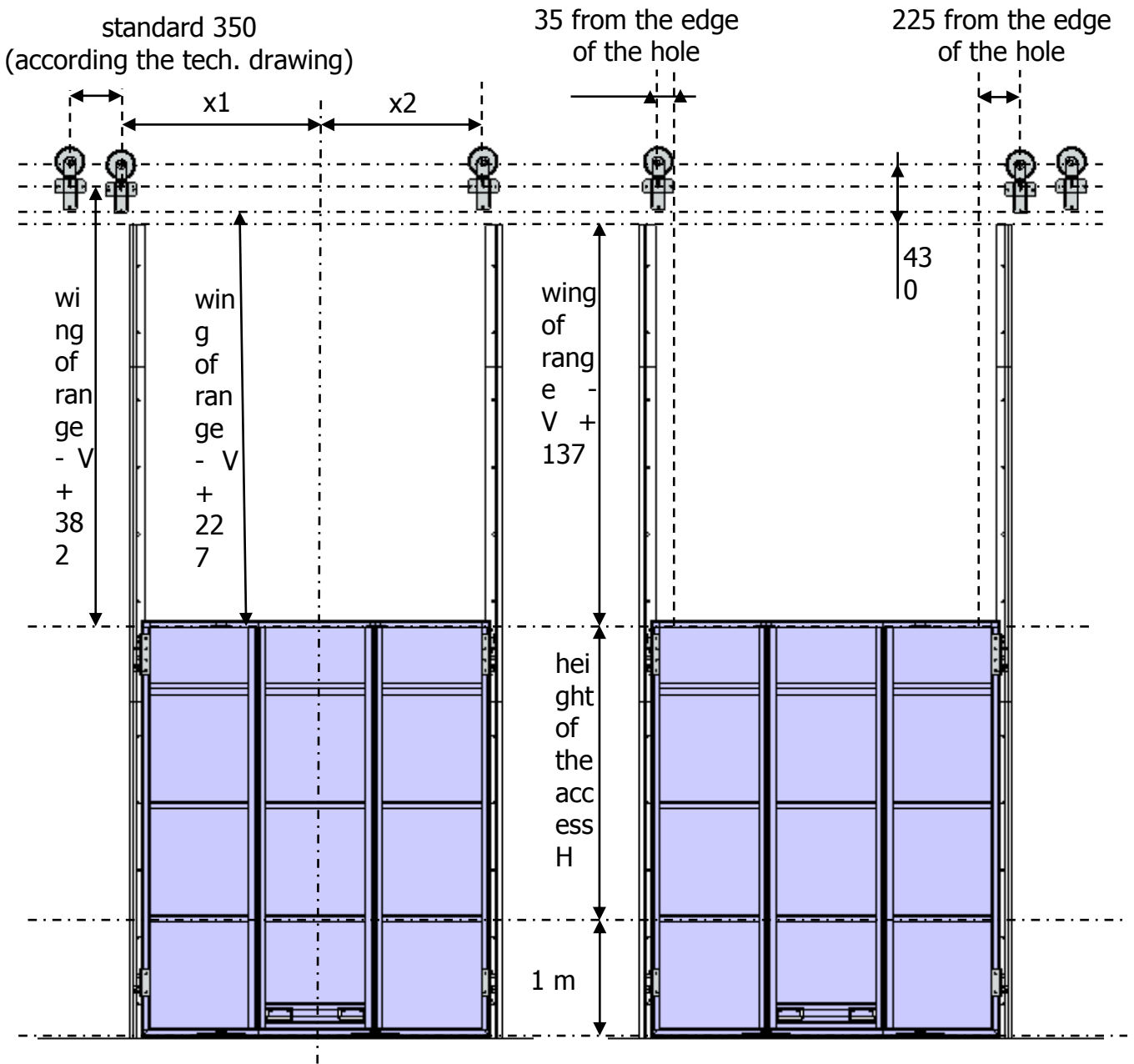

Set up the consoles to horizontal and vertical planes





8 STRUCTURE OF CONSOLE

1. 3 pcs anchors (depending on tepy of wall)
2. Matrix M-16
3. Washer
4. Pulley

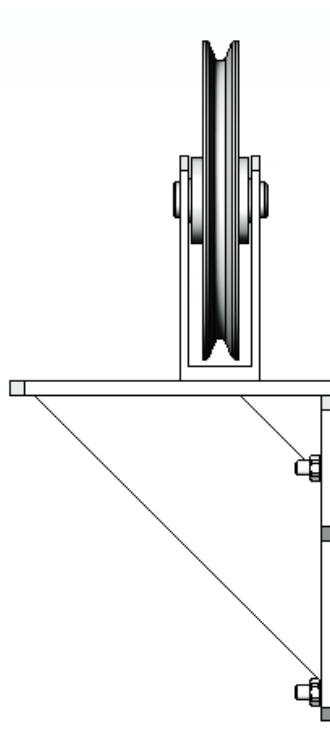
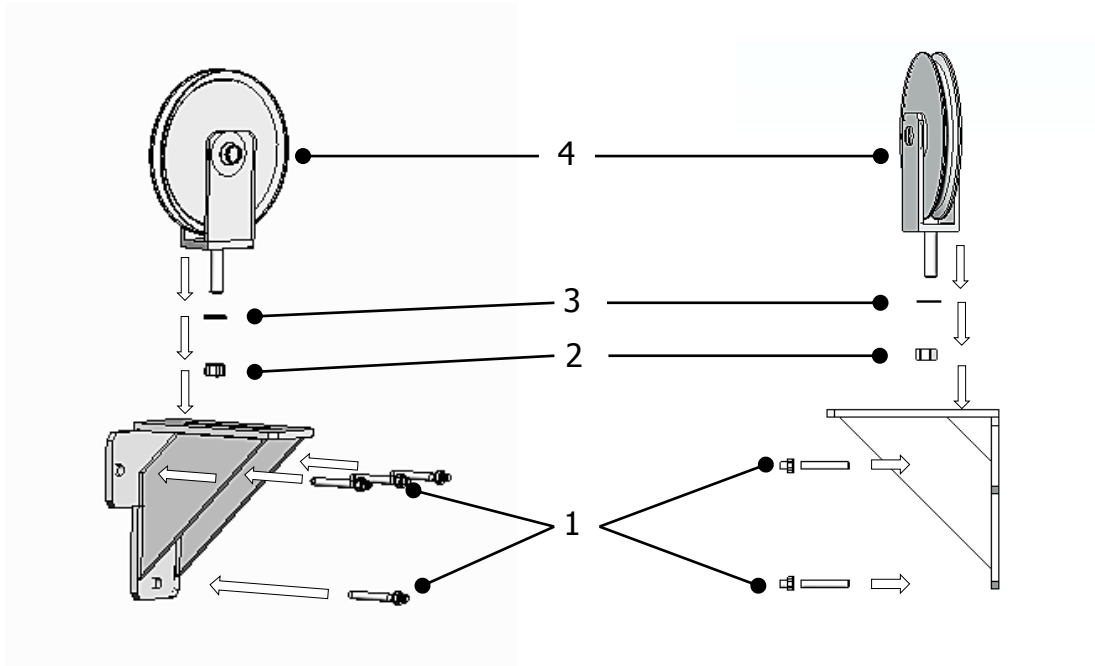



9 INSTALLATION OF COUNTERWEIGHT AND ROPE

- Pull the rope on the pulleys and pass it over pulleys of counterweight (counterweight at the top hang see. Item 5)
- Ropes are mounted on guiding wheels on both sides of the the door
- Ensure the rope in the latch of guiding pulleys must be used at least 3 cable clips
- Empty counterweight will go up

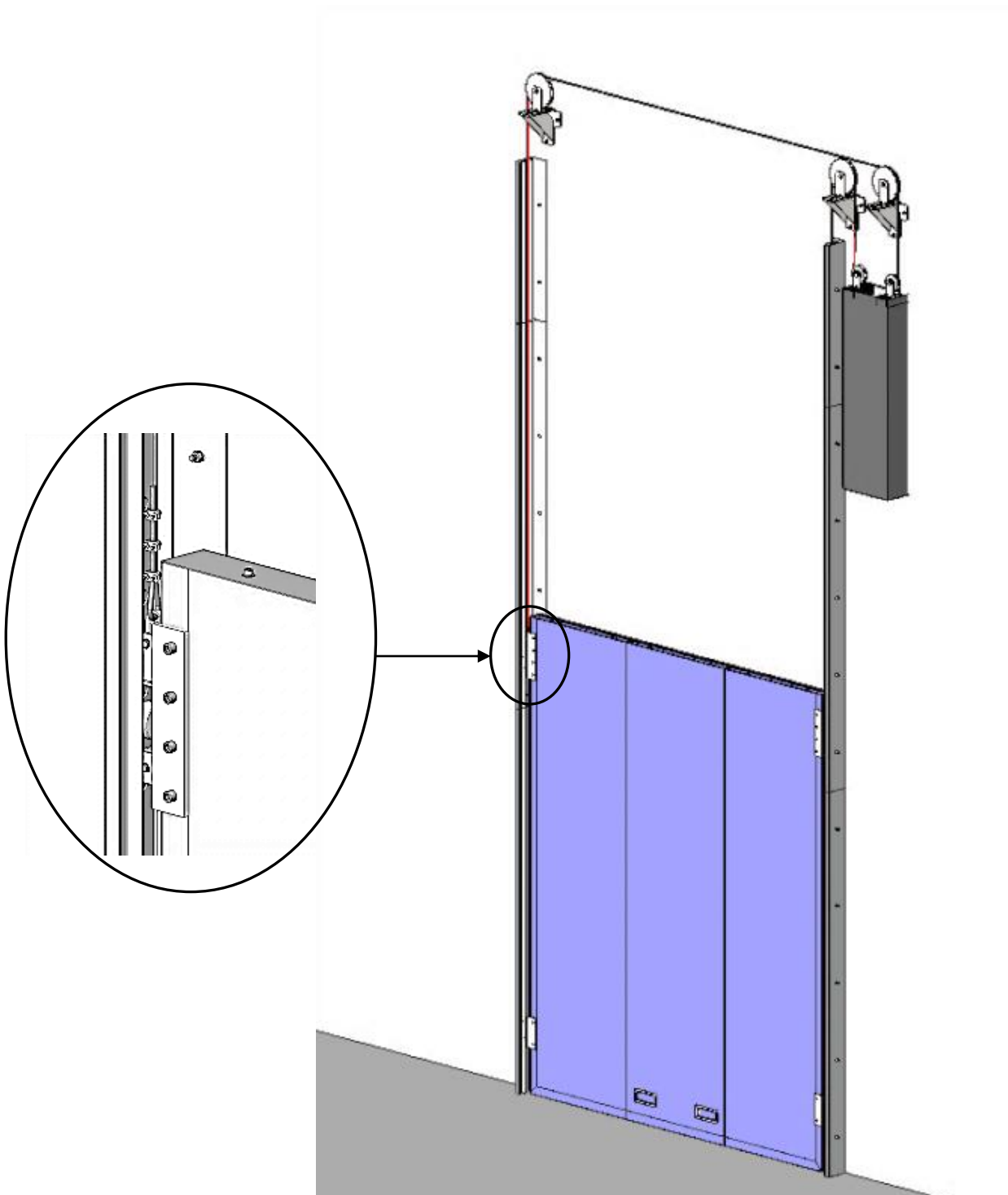



10 COUNTERWEIGHT FILLING

- Fill the counterweight by the sand or granulate, doors should be outweighed about 50 kg (difference of weight doors X counterweight). It should be adjusted according to doors resistance
- 1 sack weighs 25 kg of granulate

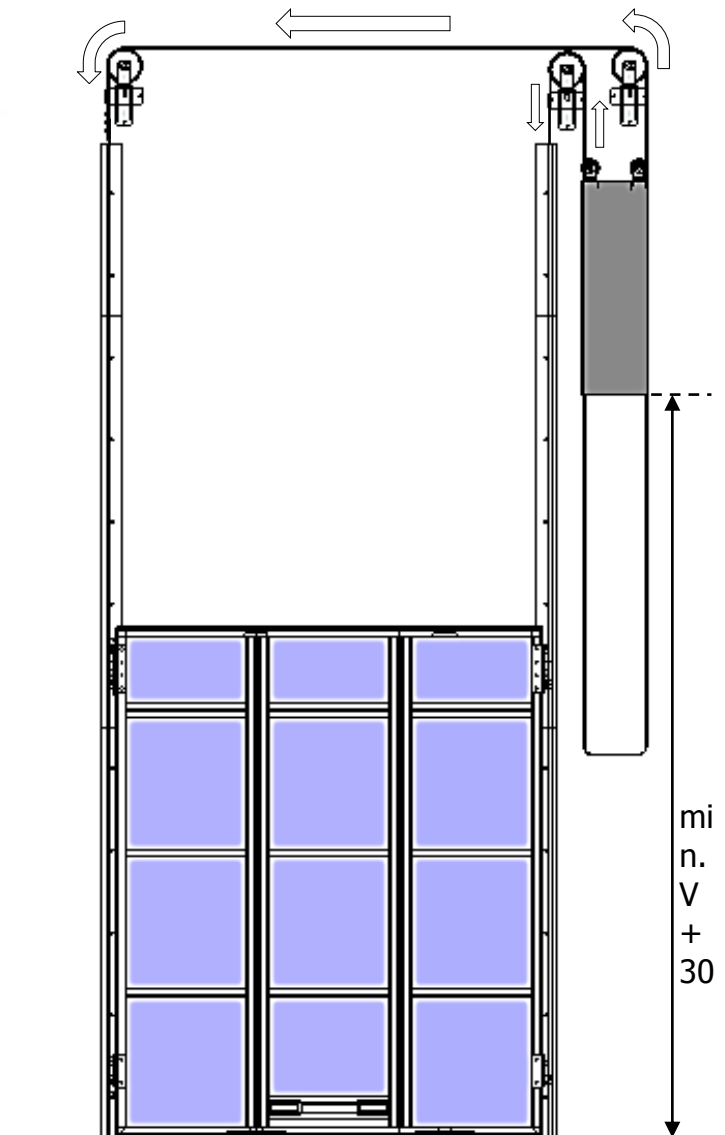
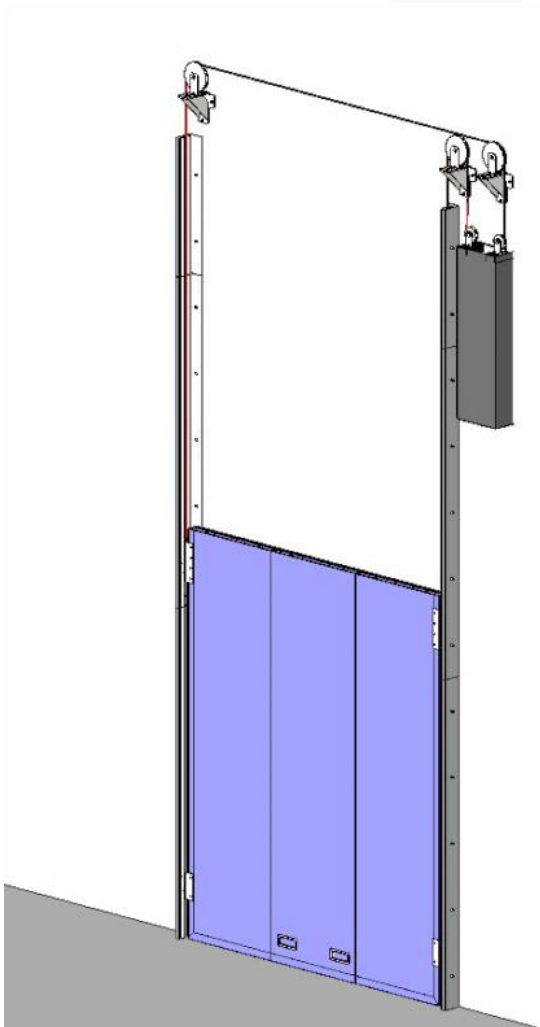
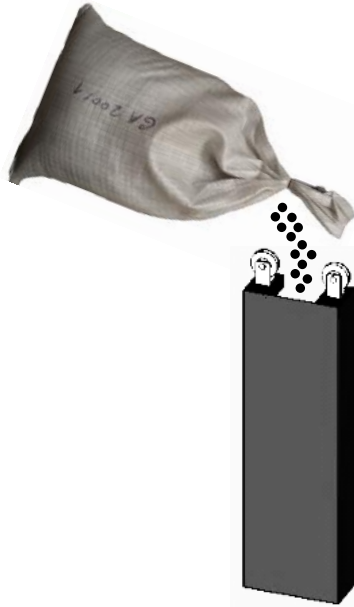



11 TRACK COVERING OF COUNTERWEIGHT

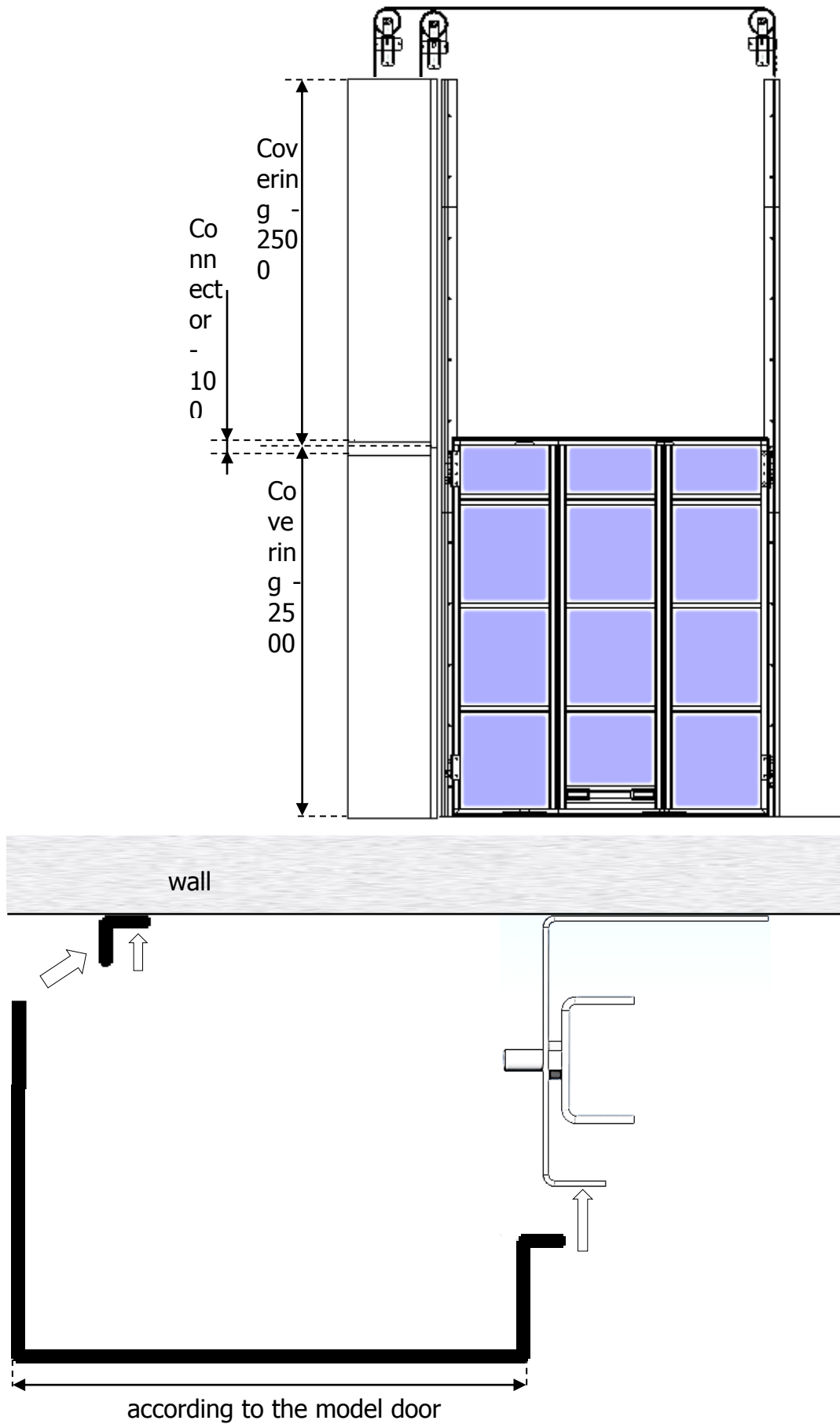



12 INSTALLATION OF DOORFRAME PROFILES

1. Labyrinth facing
2. Promat 45x25
3. Palusol 45x6

Anchor bolt as type of wall

- Expand
- Separate Palusol that covers the holes for anchoring
- Settle into positions
- Installation of anchors to the wall
- Stick Palusol that covers anchor bolts
 - paint Promat by contact adhesiveExpand

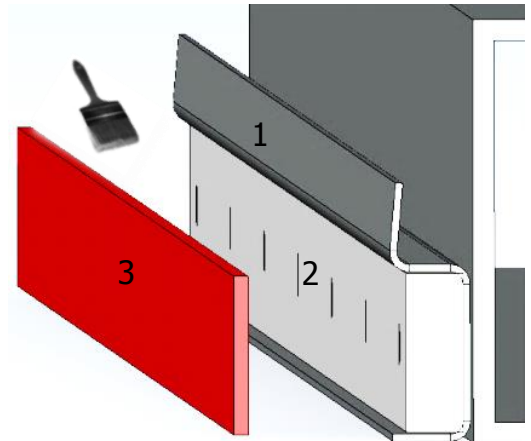

Open the door at the exit edge, we can settle the labyrinth. Implant labyrinth on the side lines (labyrinth must match and build on the boards).

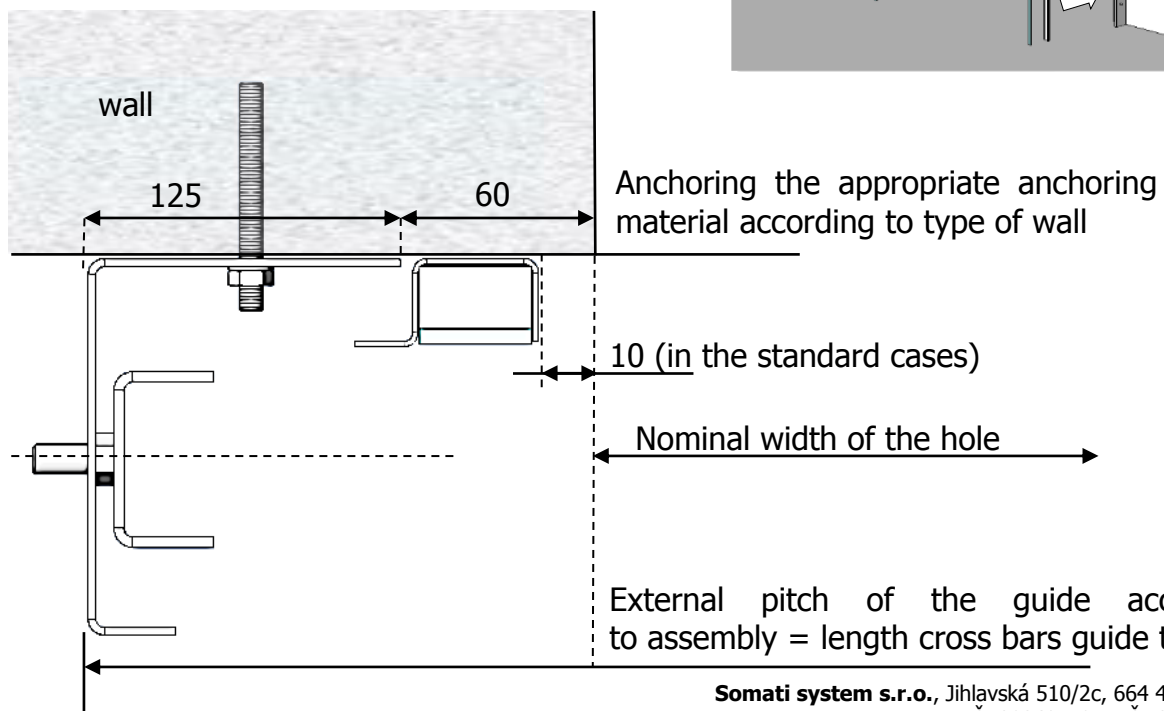
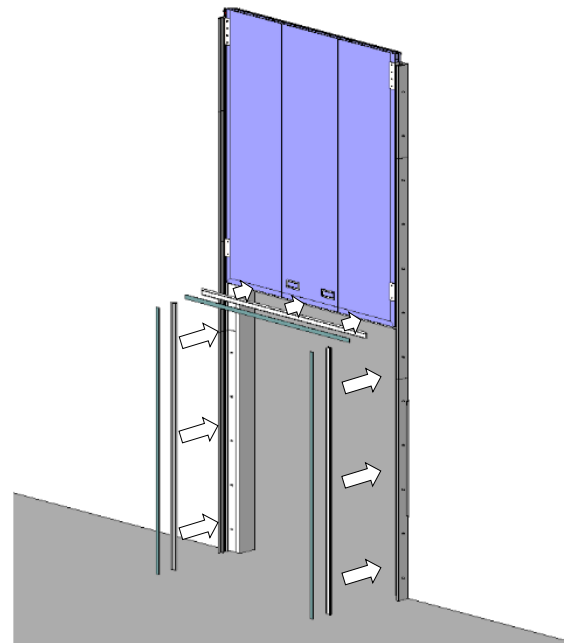
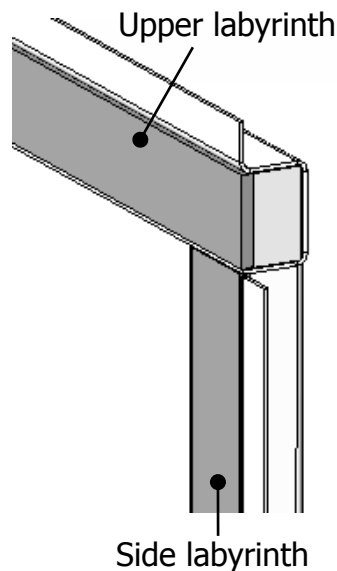



13 INSTALLATION OF THE ELECTROMAGNETIC BRAKE

Brake consoles and pulleys are placed on the outdoor side of track, with none counterweight. Screw the brake to the console (oval hole, 3 screws) and on the other side, fit the pulley on the brake, which is part of the brake. Loosen the screws on the track where they placed pulleys (see tech. drawing). Insert and tighten pulleys by screws.

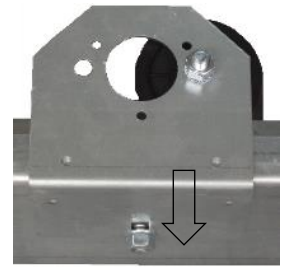

Installation of rope - loop of brake:

- Rope from door pull stretch over pulley brake and then up to the console with the pulley. Connect the rope with the clamping, which is mounted on the door pull.

Rope is connected on the inner side with a latch (screwed wing), door pull and consoles of counterweight rope clips (2 pcs on the joint) through the rope eye socket.

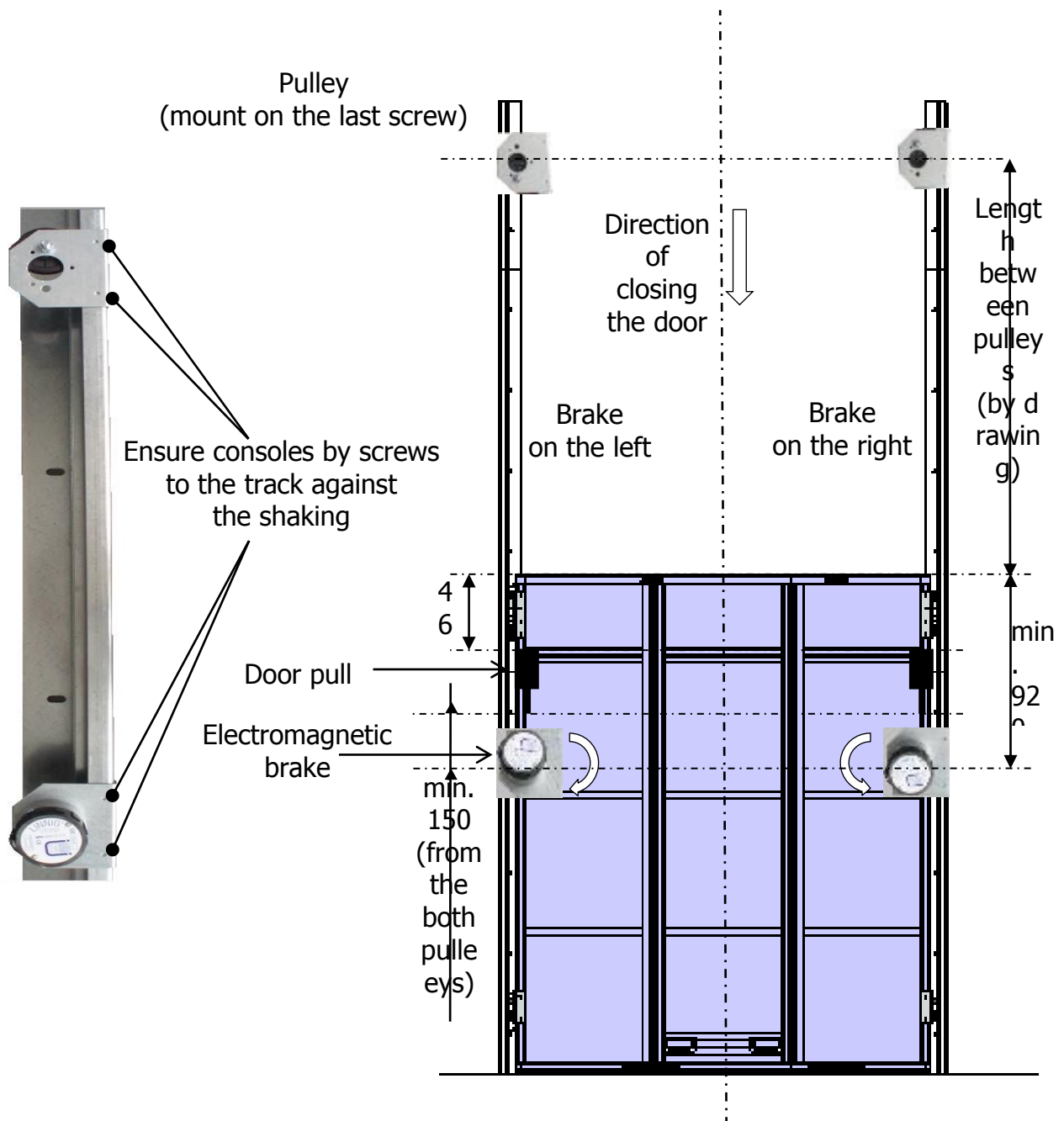



Setting of the brake

1. The pulley on the brake stops doors when they go down. When the doors pull up pulley only spins on the void. If we want to pull the door slowed, remove the pulley, turn it and re-mount
2. The lower part of the body screw brake allows the speed brake doors. Release the metal latch and rotate the bottom part. The more the lower part of the body is released the brake will be slower and closing doors will be quickly.
3. Unscrew the lower part of the most 3 to 4 turns from a maximum screw - optimal settings
4. After setting the braking speed metal latch to secure the brake grooves

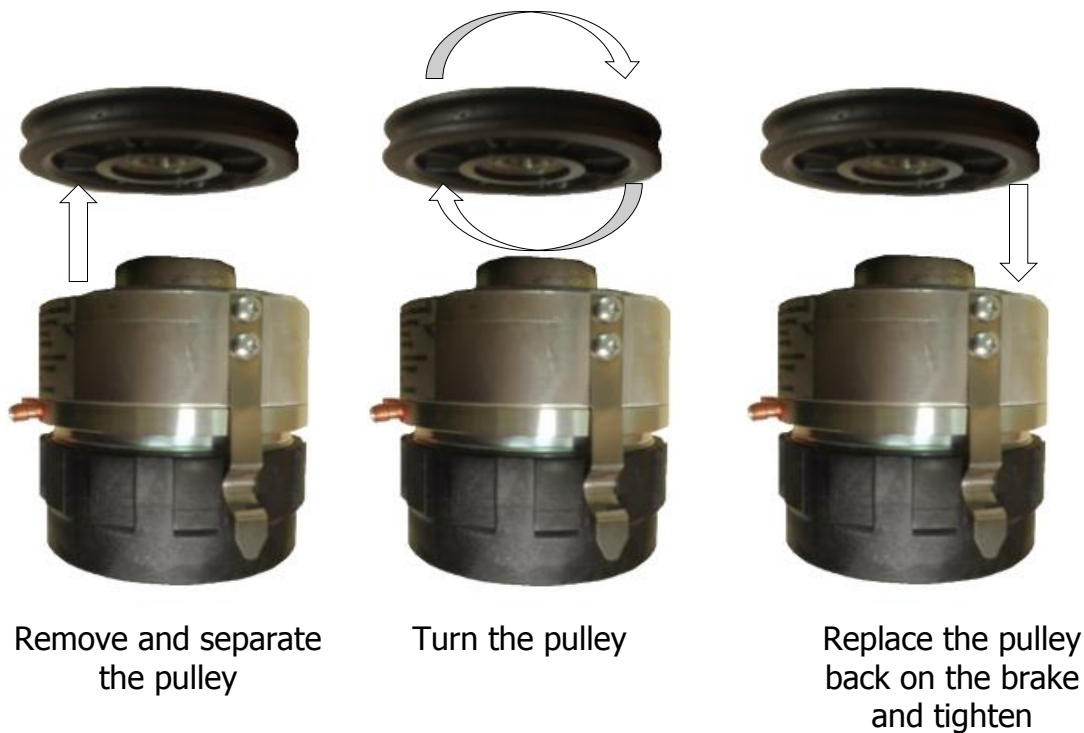
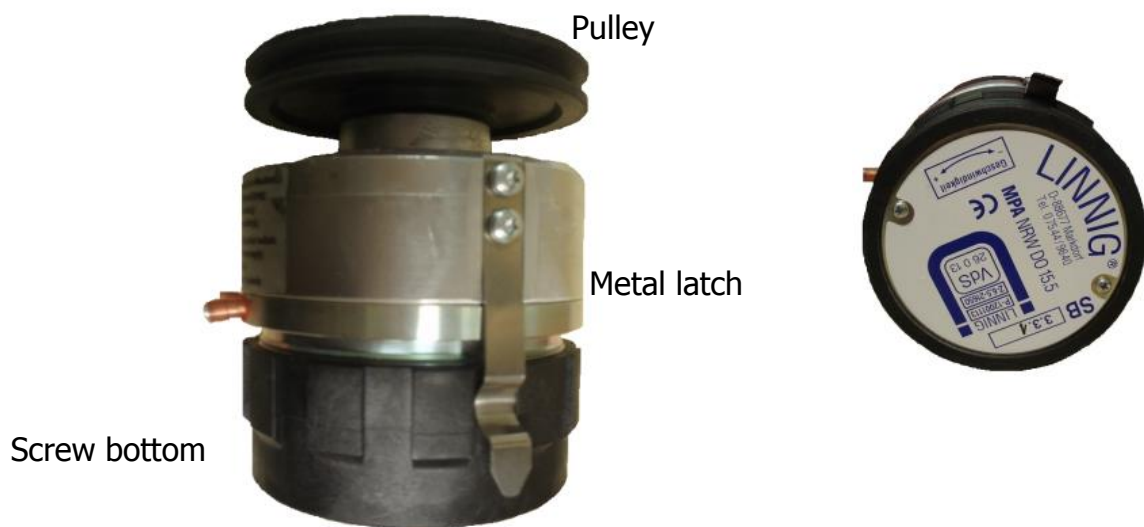



14 INSTALLATION OF STOPS

Anchoring by the relevant anchor cap

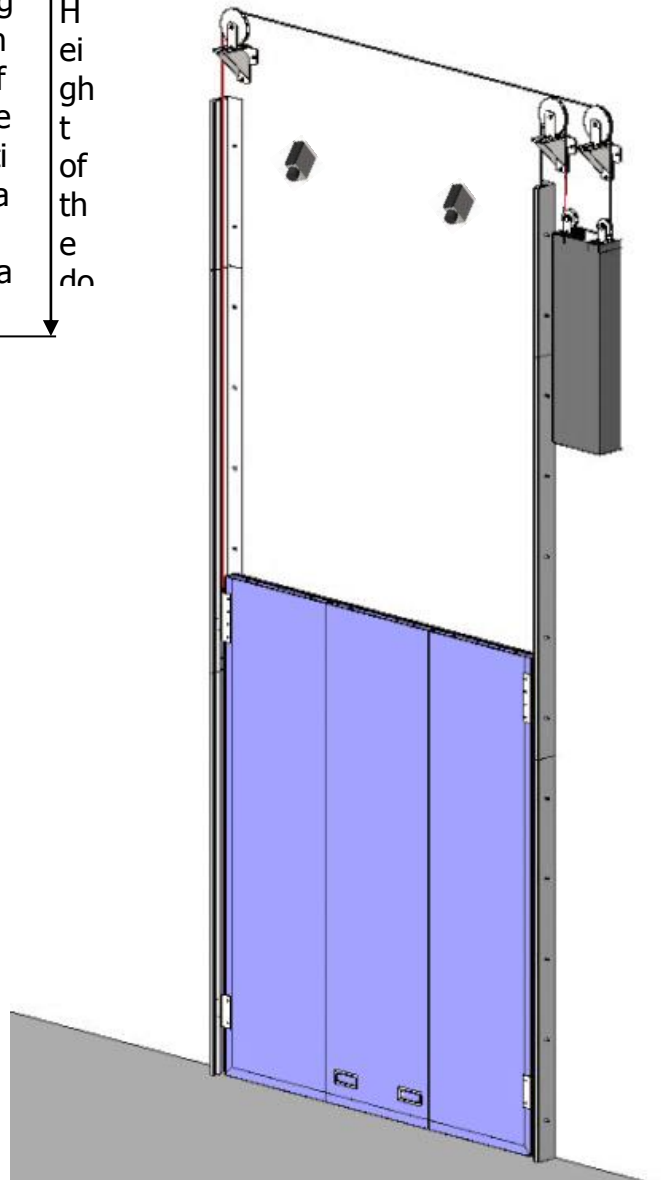
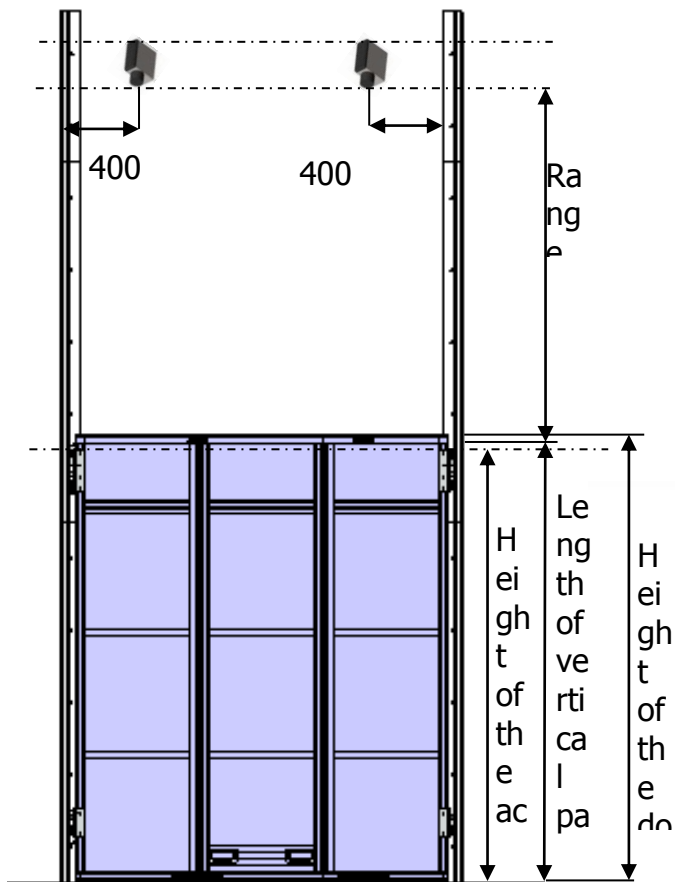

Člen ISO 9001



15 CONNECTION OF CONTROL PANEL

Viz. Manual electrical control panel

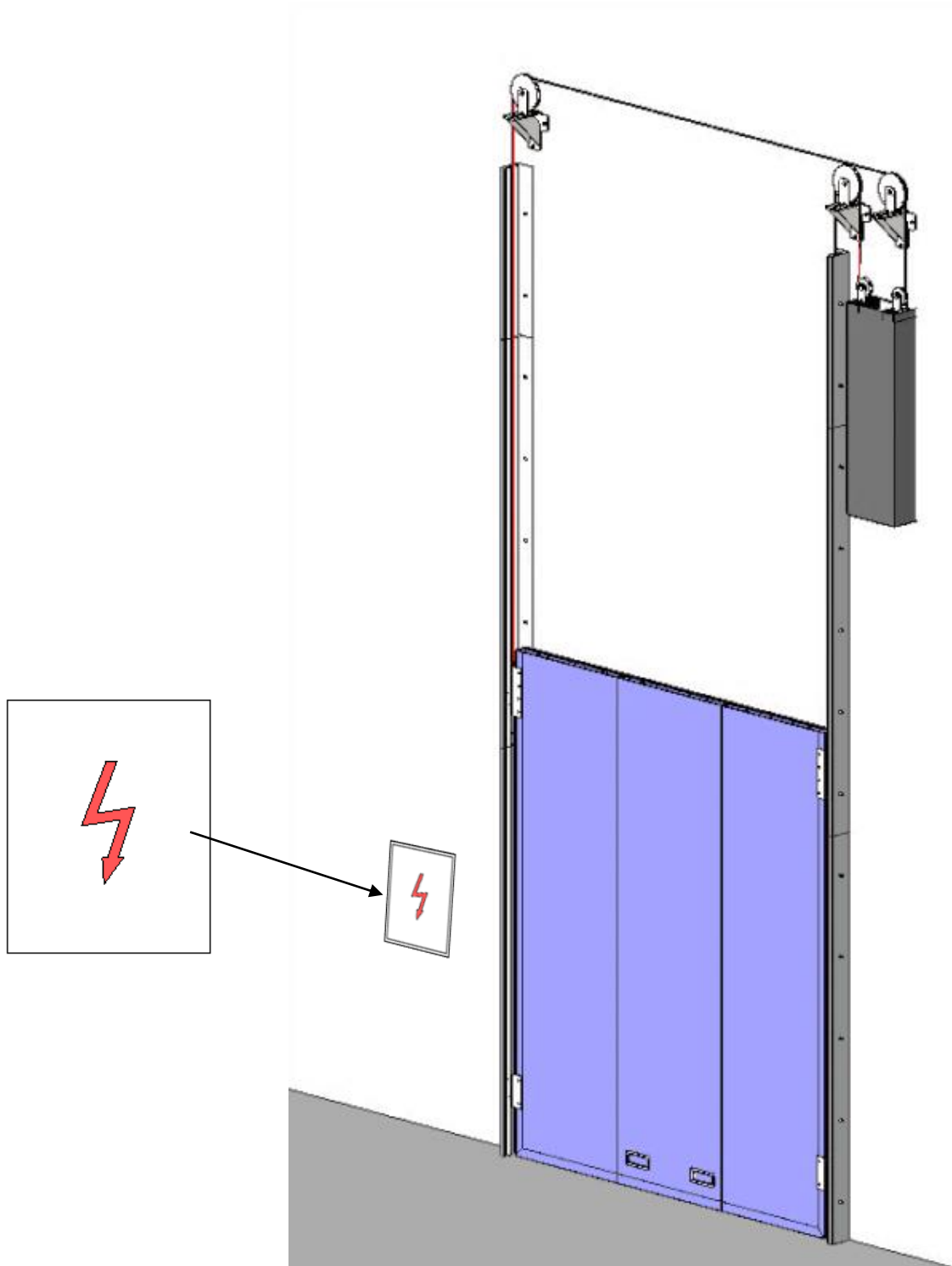



16 GUARANTEE CONDITIONS

Guarantee and product liability shall cease if you make without the consent of the manufacturer or let design changes made unqualified installation or in contravention with mounting regulations. Furthermore, the manufacturer does not accept responsibility for the unintentional or careless operation of the actuator and equipment and unqualified maintenance of the doors and balance. Supplies and materials subject to wear, such as batteries or lights are also excluded from warranty and liability claims.

In addition to the statutory warranty dealer arising from the purchase contract provided by the manufacturer depending on the type of guarantee on the drive for 2 years from date of purchase. The application of the guarantee does not extend the guarantee. For replacement parts and additional editing the warranty period is six months but at least the initial warranty period.

Guarantee claims are only valid for the country in which the door was purchased. The goods must come from channels of distribution, which was established by us. The warranty claim is valid only for damage to the subject matter of the contract. Purchase document is valid as proof of warranty claim.

During the warranty period, remove all the shortcomings of a product. That is demonstrably consequence the material or manufacturing errors. We are committed to the defective goods free of charge to according to our choice of harmless goods to replace, repair or replace inferior quality. Guarantee is excluded for damages if they happen under the following assumptions:

- Improper connections and built-in
- Improper commissioning and unprofessional staff
- Mechanical damage in an accident, fall, crash
- Damage due to negligence or wanton destruction
- Normal wear and tear
- Repairs carried out by unqualified persons
- Use of parts of foreign origin

Removing or defaced product number replaced parts become the property of the manufacturer.

